

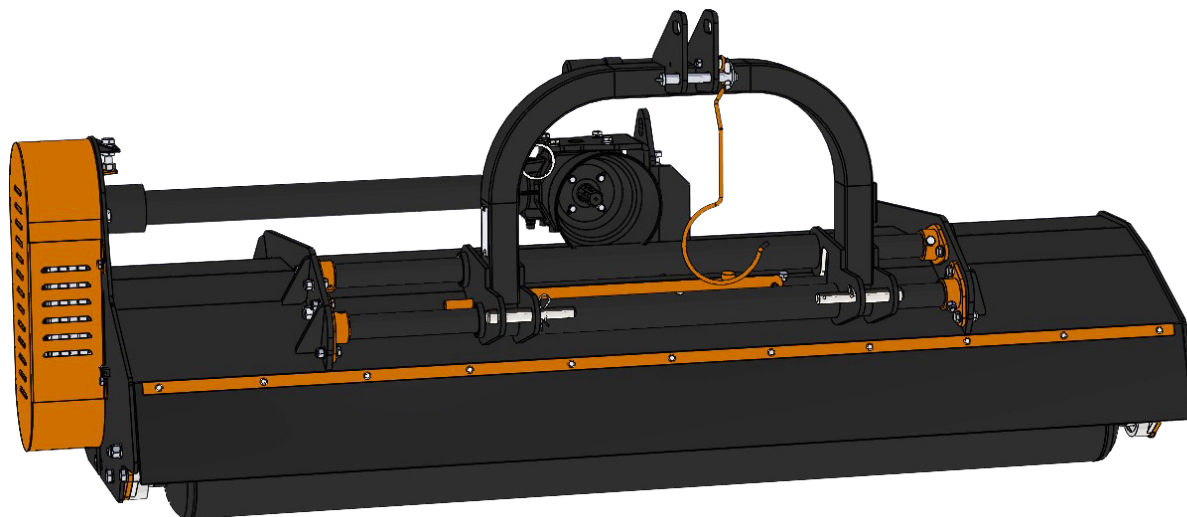









# TWIN 3

Reversible shredder, working width from 1800 to 2200 mm

3-point hitch mounted shredder. Supplied with mobile blades, suitable for shredding branches and wood up to 5 cm. diameter Double 3-point hitch shifting on self-lubricating bushings.

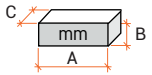

## TWIN 3 - MODEL 2906

CODIE													
	mm	mm	kw hp	n°	n/1'	kg	n°	n°	n°	A	B	C	
2916.180	1800	760 900	1180 1040	30 40	4	540	400	3	20	40	1940	1200	1000
2916.200	2000	860 1000	1280 1140	36 50	4	540	480	3	24	48	2140	1200	1000
2916.220	2200	960 1100	1380 1240	44 60	4	540	460	3	24	48	2340	1200	1000

## STANDARD EQUIPMENT

540 rpm free wheel gearbox

Forged hammer blades

Adjustable support roller Ø 194 mm

Double body

3-point hitch Cat. 1/2 with mechanical shifting

CE protection